

PRINCE OF WALES DRIVE

BATTERSEA · LONDON SW11

LIFE SAFETY EQUIPMENT USER GUIDE



CILANTRO

MEP ENGINEERING CONTRACTORS

Table of Contents

1.0 - LIFE SAFETY EQUIPMENT	1
1.1 - Fire Detection & Alarm System.....	2
1.2 - Domestic Sprinkler System.....	3
2.0 – MANUFACTURER INSTRUCTIONS	4
2.1 – Smoke & Heat Alarms Instruction Manual	4

1.1 Fire Detection & Alarm System

Apartments are provided with a network of interconnected fire detection devices manufactured by Aico UK Limited. Heat alarms are installed in kitchens, with smoke alarms located in all other rooms. A further smoke alarm is located within the utility cupboard.



Figure 5.1 - A Heat Alarm
Make: Aico - Model: Ei144RC



Figure 5.1B - A Smoke Alarm
Make: Aico - Model: Ei146RC

All detectors are wired together and come complete with in-built sounders, allowing audible warning of a detection incident throughout the property (regardless of the exact location of the hazard). Each heat or smoke detector is also provided with a backup battery, allowing continued operation for up to 72 hours in the event of mains power failure.

Important

Routine testing of heat and smoke alarms should be carried out on a weekly basis by the apartment occupants. Please refer to the manufacturer's instruction manual for a step-by-step guide.

1.2 Domestic Sprinkler System

All properties are also fitted with a domestic sprinkler system, which is served by dedicated pipework (easily identifiable by its distinctive orange colouring). Heads are installed at ceiling level and come complete with white cover plates. An alternative model of head and cover plate is also provided at high level within the utility cupboard.

Operation of sprinkler heads will occur automatically during the intense heat generated by a fire.



Figure 5.2A - A Sprinkler Head
Make: Rapidrop - Model: RD208



Figure 5.2B - Utility Cupboard Model
Make: Rapidrop - Model: F1Res44 HSW

Testing of the residential sprinkler system is carried out annually by the building manager. The procedure does not require that access to individual apartments be made available.

2. Manufacturer Instructions

2.1 Smoke & Heat Alarm Instruction Manual

Please refer to the document on the following page for the Smoke and Heat Alarm Instruction Manual.

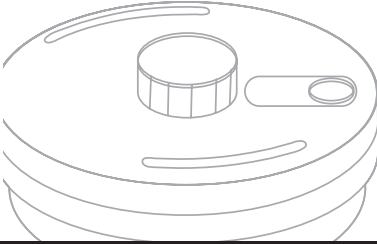
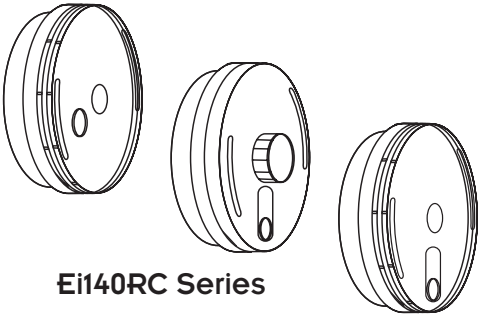

230V~ SMOKE & HEAT ALARMS

with Alkaline Battery Backup

Instruction Manual

Contact Us

Aico Ltd

Mile End Business Park, Maesbury Rd, Oswestry,
Shropshire SY10 8NN, U.K.

Tel: 01691 664100

www.aico.co.uk

Ei Electronics

Shannon, Co Clare, Ireland.

Tel: 061 471277

www.eielectronics.com

User Section

Introduction to Ei140RC Smoke/Heat Alarms

The Ei140RC series is supplied with an Easi-Fit base that allows very quick and simple installation of the Smoke Alarm, combined with simple detector head removal and replacement. The Easi-Fit base automatically connects both mains power and battery as the detector head slides on to the Easi-Fit base.

Up to 12 Smoke/Heat Alarms can be interconnected so that when one senses fire all the units alarm.

Interconnection can be achieved by hardwire or through a RadioLINK Base, the Ei168RC.

A green LED indicates the presence of mains power. A red LED will flash rapidly in an alarm scenario.

All Alarms feature a combined test/hush button.

The "Test/Hush" button will either silence false alarms or perform a unit self-test.

In "Test" mode the Alarm will perform a self-test and sound the horn.

In "Hush" mode the Alarm will be silenced for a period of approximately ten minutes to overcome false alarm conditions. It will then automatically reset itself.

RF Interconnection

The Ei140RC series may be interconnected with any other Ei Electronics RadioLINK or RadioLINK+ products through fitting onto an Ei168RC RadioLINK Base. This base will enable the Ei140RC series Alarms to communicate RF messages to other Ei Electronics products such as the Ei450 RadioLINK Alarm Controller where you can remotely locate, test and hush your Ei140RC Series Alarms using this wireless controller.

For detailed user instructions on using the RF interconnection base Ei168RC with the Ei140RC series, please consult the Ei168RC instruction manual.

Important Information

Do's	Don'ts
Regularly check green mains indicator is lit	Do not paint your Alarm. Do not allow paint, water or dust to contaminate the Alarm
Test Weekly – See testing and maintenance	Your Alarm is powered by 230VAC. Do not open or insert anything into the Alarm
If nuisance alarms occur – press the test/hush button to silence the Alarm for 10 mins	
Clean your Alarm regularly	
Remove or completely cover your Alarm when decorating to prevent dust or other contamination damaging the unit	

Changing The Battery

1. Switch off mains power to Alarm (green light on cover should go out).
 2. Remove unit as shown in "ALARM REMOVAL" section on page 11.
 3. Locate battery slot in base of Alarm as shown below.
 4. Unclip battery from battery snap connectors.
 5. Connect new battery by clipping back on to battery snap connectors. Use only 9V Alkaline batteries Duracell MN1604, Energizer 522. Other batteries can cause problems.
- We recommend that the "replace by date" on the battery should still have at least 2 years to go. Older batteries will give beeps prematurely.
6. Slide unit back on to the base. A click should be heard as the Alarm engages. (The unit cannot be replaced on the base unless a battery is installed).
 7. Press and hold the test button - horn should sound loudly.
 8. Reinststate mains power to Alarm (green light on cover should come on).

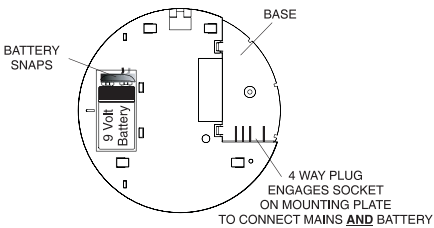

Testing and Maintenance

Check all Alarms weekly, especially after initial installation or re-occupation (e.g. following a holiday)

1. Check that the green mains indicator light is on. (if it is off check circuit breakers, fuses and wiring etc.)
2. Check that the red LED on the cover flashes once every 40 seconds to indicate normal operation – If the memory has been set indicating that the Alarm has been activated in the last 24 hours, the red LED will flash twice every 40 seconds. After 24 hours the memory will be cleared.
3. Press the test button for up to 10 seconds to ensure the sensor chamber, electronics and sounder are working. A red light on the cover, will flash while horn is sounding. The alarm will stop when the button is released. Pressing the test button simulates the effect of smoke or heat during a real fire and is the best way to ensure the Alarm is operating correctly. This action will also clear the memory.

WARNING: DO NOT TEST WITH FLAME

This can set fire to the Alarm and damage the house.

We do not recommend testing with smoke or heat as the results can be misleading unless special apparatus is used.

4. Check for any sign of contamination such as cobwebs or dust and clean the Alarm as described in the "cleaning" section if necessary.

5. Interconnected Alarms only - Test the first unit by pressing the button for 10 seconds. All the units should alarm within 10 seconds of the first horn sounding. The red light on the first unit only will flash about once a second. On releasing the button the local Alarm will stop sounding immediately and the remote Alarms will stop sounding approximately 3 seconds later (if testing using RF interconnection this could take slightly longer). This will verify that the interconnect is working. Check all the other units similarly.
6. Check the functioning of the mains battery back-up directly after installation and then at least yearly as follows:
 - Turn off the mains power at the distribution board and check that the green indicator light is extinguished.
 - Press the test button and ensure the horn sounds loudly for 10 seconds.

Turn on the mains supply at the distribution board only if the unit passes the above test.

Note: If the mains is disconnected and the battery is almost depleted the unit will beep every 40 seconds for at least 30 days.

7. Monitor the Alarm over a short period of time for any beeps.

Switching off Mains for long periods

If the premises are regularly being left without mains power for long periods the Smoke/Heat Alarms should be removed from their mounting plates to prevent the batteries becoming fully depleted. (This is sometimes done with holiday homes which are only occupied in the Summer).

The Alarms must be re-attached to the mounting plates when the premises are re-occupied.

If the unit is beeping: Before replacing the battery, check that the beeps are not due to one of the following:

- (i) battery snaps not connected properly.
- (ii) On the Optical Smoke Alarm only (Ei146RC) if the unit beeps and the red light does not flash at the same time it indicates a problem with the smoke chamber - see "**Cleaning Your Alarm**" section.
- (iii) If the beeps have continued for over 20 minutes (and the other causes of beeps have been ruled out - see "**Troubleshooting**" section) the battery must be replaced. See "**Changing the Battery**" section.

Cleaning your Alarm

If all of the above possible causes of beeps have been ruled out, but the beeping has still persisted for over 2 hours with the green light on - replace the Alarm. The Smoke / Heat Alarm can be returned to the manufacturer for repair or replacement - see "**Service and Guarantee**" section.

WARNING: Electrical shock hazard. Disconnect the AC mains at the fuse box or circuit breaker powering the Alarm before following the cleaning instructions.

Clean your Alarm regularly, particularly in dusty areas. Use the narrow nozzle attachment of your vacuum cleaner to remove dust, insects and cobwebs from the sides and cover slots where the smoke or heat enters. To clean the cover, wipe with a damp cloth. Dry cover thoroughly with a lint free cloth.

WARNING: Do not paint your Alarm.

Other than the cleaning described above, no other customer servicing of this product is required. Repairs, when needed, must be performed by the manufacturer. All Alarms are prone to dust and insect ingress which can cause nuisance/false alarms or failure to alarm.

In certain circumstances even with regular cleaning, contamination can build up in the smoke sensing chamber causing the Alarm to sound or fail. If this happens the Alarm can be returned to us for servicing or replacement. Contamination is beyond our control, it is totally unpredictable and is considered normal wear and tear.

For this reason, contamination is not covered by the guarantee and a charge is made for servicing such units. If you experience persistent nuisance/false alarms it may mean that the environment may not be suitable for your particular Alarm type.

Nuisance / False Alarms

When sure that it is just a nuisance/false alarm, simply press the test/silence button briefly on the Alarm to silence the unit for 10 minutes.

If, when the alarm goes off, there is no sign of smoke, heat or noise to indicate that there is a fire, you should get your family into a safe place, before you start investigating.

Check the house carefully in case there is a small fire smouldering somewhere.

Check whether there is some source of smoke or fumes, for example cooking fumes being drawn past the Smoke Alarm by an extractor.

If there are frequent nuisance/false alarms it may be necessary to re-locate the device away from the source of the fumes. If for some reason the Alarm continues to sound without smoke or heat being present (due to insect infestation or contamination build-up for example) the units can be silenced by disconnecting the mains power and removing the unit - see "**ALARM REMOVAL**" section - page 11 (Installer section).

If cleaning the Alarm does not correct the problem it can be returned to the manufacturer for repair or replacement - see "Service and Guarantee" section.

Silence Feature

All the Smoke Alarms have a combined Test/Silence Button to help you control nuisance/false alarms.

1. To silence a nuisance/false alarm, press the Test/Silence Button located on the cover. The Alarm will automatically switch to a reduced sensitivity condition for a 10 minute period (very large levels of smoke from a nearby fire will override the silence period).

The unit will flash the red light every 10 seconds (instead of the normal 40 seconds) to indicate the sensitivity is reduced.

On interconnected Alarms, pressing the Test/Silence Button on the one sensing smoke (i.e. the one with the red light flashing every second) will silence all alarms.

Pressing the Silence Button on any other Alarm will not silence the alarm.

2. The unit will reset to normal sensitivity at the end of the silenced period.

Planning Your Escape Route

Use the Smoke / Heat Alarm Test Buttons to familiarise your family with the Alarm sound and to practice fire drills regularly with all family members. Draw up a floor plan that will show each member at least 2 escape routes from each room in the house.

Children tend to hide when they don't know what to do. Teach children how to escape, open windows, and use roll up fire ladders and stools without adult help. Make sure they know what to do if the alarm goes off.

1. Check room doors for heat or smoke. Do not open a hot door. Use an alternate escape route. Close doors behind you as you leave.

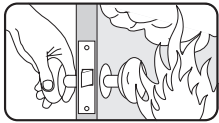

2. If smoke is heavy, crawl out, staying close to floor. Take short breaths, if possible, through a wet cloth or hold your breath. More people die from smoke inhalation than from flames.



3. Get out as fast as you can. Do not stop for packing. Have a prearranged meeting place outside for all family members. Check everybody is there.



4. Call the Fire Brigade immediately on a mobile phone or from a neighbour's house. Make sure to call the Brigade for all fires no matter how small - fires can suddenly spread. Also call the Brigade even if the alarm is automatically transmitted to a remote manned centre - the link may have failed.



5. **NEVER** re-enter a burning house.

Limitations of Smoke / Heat Alarms

Smoke / Heat Alarms have significantly helped to reduce the number of fire fatalities in countries where they are widely installed.

However independent authorities have stated that they may be ineffective in some circumstances. There are a number of reasons for this:

- NOTE: Constant exposure to high or low temperatures or high humidity may reduce the life of the battery.
- Smoke / Heat Alarms will not detect fire if sufficient smoke / heat does not reach the Alarm. Smoke / heat may be prevented from reaching the Alarm if the fire is too far away, for example, if the fire is on another floor, behind a closed door, in a chimney, in a wall cavity, or if the prevailing air draughts carry the smoke / heat away. Installing Smoke / Heat Alarms on both sides of closed doors and installing more than one Smoke

/ Heat Alarm as recommended in the 'INSTALLER INSTRUCTIONS' section significantly improves the probability of early detection.

- The Alarm may not be heard.
- A Smoke / Heat Alarm may not wake a person who has taken drugs or alcohol.
- Smoke / Heat Alarms may not detect every type of fire to give sufficient early warning.
- Smoke / Heat Alarms don't last indefinitely. For example if there is a build up of contamination, performance will be impaired.

It is recommended that the Smoke / Heat Alarms are replaced after 10 years as a precaution.

Service and Guarantee

If your Alarm fails to work after you have carefully read all the instructions, checked the unit has been installed correctly, and is receiving AC power (green light on) contact Customer Assistance at the address given at the end of this leaflet. If it needs to be returned for repair or replacement put it in a padded box and send it to "Customer Assistance and Information" at the nearest address given on the Alarm or in this leaflet. Do not snap on to the mounting plate as this connects the battery and the unit may beep or alarm in the post. State the nature of the fault, where the Alarm was purchased and the date of purchase.

Ei Electronics guarantees this Alarm for five years from date of purchase against any defects that are due to faulty materials or workmanship. This guarantee only applies to normal conditions of use and service, and does not include damage resulting from accident, neglect, misuse, unauthorised dismantling, or contamination howsoever caused. This guarantee excludes incidental and consequential damage. If this Alarm should become defective within the guarantee period, it can be returned to Ei Electronics, with proof of purchase, carefully packaged, with the problem clearly stated. We shall at our discretion repair or replace the faulty unit.

Do not interfere with the Alarm or attempt to tamper with it. This will invalidate the guarantee, but more importantly may expose the user to shock or fire hazards.

This guarantee is in addition to your statutory rights as a consumer.

Troubleshooting

1. ALARM SOUNDS FOR NO APPARENT REASON:

(1) Identify the alarm source. On interconnected units, the red light on the cover will flash rapidly only on the unit which is the source of the alarm. If an optional Ei1529RC Control Switch or an Ei450 Alarm Controller is installed, press Locate when the system is sounding to identify source of alarm.

(2) Check for fumes, steam etc. from the kitchen or bathroom. Paint and other fumes can cause nuisance/false alarms.

(3) Press the test/silence button to silence the Smoke/Heat Alarm for 10 minutes.

(4) If alarm does not stop, switch off mains and remove unit - see "Important Information" section. (Only remove

the alarm with the red light flashing, the others are probably satisfactory).

2. LOW BATTERY & OTHER BEEPS:

(1) If the battery is correctly connected and the unit has beeped for over 20 minutes the battery is probably depleted. Obtain a new battery, disconnect the mains, then remove the Alarm and replace the depleted battery.

(2) If the Ei146RC beeps without the red light flashing at the same time, the chamber is defective. See 'Cleaning your Alarm' section.

(3) If the green mains light is on and replacing the battery or cleaning the unit has not stopped the beeps, a fault may exist. Disconnect the mains first and replace the unit - see "**Alarm Removal**" section.

3. INTERCONNECTED ALARMS DO NOT ALL SOUND:

(1) Hold test button for 10 seconds after first Alarm has sounded to ensure signal is transmitted to all units.

(2) One or more of the connections may not be correctly connected. We recommend you consult a qualified electrician.

The crossed out wheelee bin symbol that is on your product indicates that this product should not be disposed of via the normal household waste stream. Proper disposal will prevent possible harm to the environment or to human health. When disposing of this product please separate it from other waste streams to ensure that it can be recycled in an environmentally sound manner. For more details on collection and proper disposal, please contact your local government office or the retailer where you purchased this product.



CE
0086

Ei Electronics, Shannon, Co. Clare, Ireland
08
DoP No.13-0001

EN14604:2005 + AC:2008

Smoke Alarm Devices:
Ei141RC, Ei146RC

Fire Safety

Nominal activation conditions/ sensitivity, response delay (response time) and performance under fire condition	Pass
Operational reliability	Pass
Tolerance to voltage supply	Pass
Response delay and temperature resistance	Pass
Vibration resistance	Pass
Humidity resistance	Pass
Corrosion resistance	Pass
Electrical stability	Pass

CE

Heat Alarm Devices:
Ei144RC

The Declaration of Performance No. 13-0001 may be consulted at www.eielectronics.com/compliance

Installer Section

Installation Guide

1 LOCATE CORRECT SITING POINT

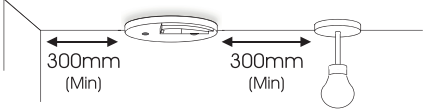

ALARM SHOULD BE CEILING MOUNTED AT LEAST 300mm FROM WALLS & OBSTRUCTIONS, IDEALLY CENTRALLY IN ROOM/AREA

2 FIX & WIRE BASEPLATE

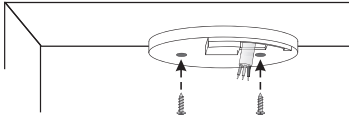

WIRE TO TERMINALS ON THE BASEPLATE AND FIX BASEPLATE TO CEILING USING THE FIXINGS PROVIDED

3 SLIDE ON ALARM

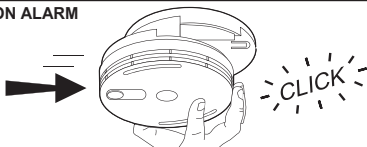

SLIDE ALARM ONTO BASEPLATE. A CLICK SHOULD BE HEARD AS THE TAMPER-PROOF CATCH ENGAGES

4 TEST ALARMS



PRESS AND HOLD THE TEST BUTTON ON THE ALARM. THE ALARM AND ANY OTHER INTERCONNECTED UNITS SHOULD SOUND

ATTENTION: THIS SECTION IS ONLY A GUIDE. PLEASE READ FULL INSTRUCTIONS BEFORE INSTALLATION

Alarm Removal

⚠ DISCONNECT MAINS BEFORE REMOVAL

1 LOCATE REMOVAL SLOT & INSERT SCREWDRIVER

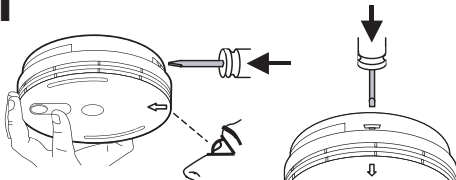

LOCATE THE ARROW ON THE FRONT FACE OF THE ALARM THE SLOT IS LOCATED DIRECTLY ABOVE THE ARROW INSERT A FLAT-BLADED SCREWDRIVER HORIZONTALLY APPROX. 1cm INTO THE CENTRE OF THE REMOVAL SLOT

2 SLIDE ALARM OFF BASE & REMOVE ALARM

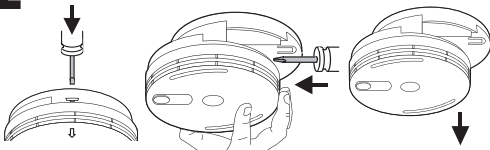

WITH THE SCREWDRIVER STILL INSERTED, PUSH THE LOWER HALF OF THE ALARM AWAY FROM THE SCREWDRIVER, IN THE DIRECTION OF THE ARROW ON THE COVER

How Many Alarms To Install - Categories & Grades

The advice here follows the guidance in British Standard BS 5839-6: 2013 in general (for further information see the BS standard itself).

The main reason for fitting Smoke & Heat Alarms in dwellings is to ensure that when there is a fire, sufficient early warning is given so that everybody can escape safely.

This means that the fire alarms should ideally be located near all potential sources of fires and that the alarm should be heard throughout the house – particularly in the bedrooms.

It is also important that nuisance/false alarms are minimised to ensure the units are not disabled or ignored.

The BS standard gives guidance on:

- how many Alarms to install
- what type of Alarm to use
- where to position Alarms

The above points will depend on the type of dwelling to be protected and the level of fire risk.

Fire Risk Assessment

The 'Grade' and 'Category' of system that should be installed depends on the fire risk. The risk assessment is based on a combination of probabilities:

- fire occurring
- injury or death to occupant
- system operating correctly with a fire
- early detection and warning to occupants in the event of a fire.

The greater the risks, the more comprehensive and reliable systems need to be.

UK Requirements (BS 5839-6:2013)

LD1 OPTIMUM PROTECTION

for dwellings where occupants may be at high risk (e.g. elderly)

Optimum Protection LD1: As LD2, but in addition Smoke or Heat Alarms should be located in all rooms and other areas of the dwelling.
(apart from toilets or bathroom)
Interconnect all Alarms

LD2 BASIC PROTECTION

for new or materially altered dwellings or existing dwellings with poor structural fire precautions

Basic Protection LD2: Smoke or Heat Alarms in all rooms or areas that present a high fire risk to occupants.
(apart from toilets or bathroom)
Interconnect all Alarms

LD3 MINIMUM PROTECTION

Minimum Protection LD3: Alarms in all hallways, stairways and circulation areas that form part of the escape routes from the dwelling.

 **Multi-Sensor or Smoke Alarms** located:

- on each storey
- every 7.5 m of hallways and escape routes
- within 3m of all bedroom doors
(apart from toilets & bathrooms ☒)

 **Heat Alarms** located in:

- each Kitchen
(Heat Alarms must be within 5.3m of potential fire sources)

 **Multi-Sensor or Heat Alarms** located in:

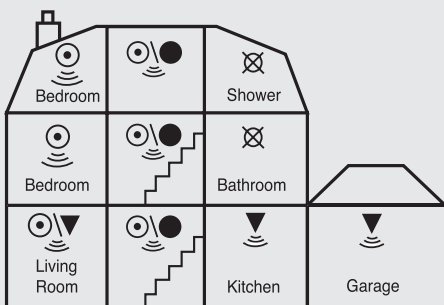

- each Living room (i.e. most frequently used daytime room)

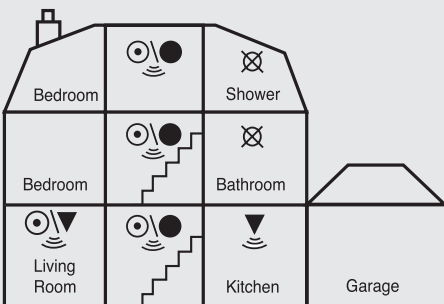

Multi Storey Dwelling LD1



Multi Storey Dwelling LD2

 Multi-Sensor Fire Alarm
  Optical Smoke Alarm
  Heat Alarm
  do not fit Alarm

ROI Requirements (IS 3218:2013)

LD1 OPTIMUM PROTECTION

for dwellings where occupants may be at high risk (e.g. elderly)

Optimum Protection LD1: As LD2, but also including attics / lofts / other spaces in which a fire might start (apart from toilets or bathroom).



Interconnect all Alarms

LD2 BASIC PROTECTION

for new or materially altered dwellings or existing dwellings with poor structural fire precautions

Basic Protection LD2: all circulation areas that form part of an escape route within the dwelling, and all high fire risk areas / rooms e.g. kitchen, living rooms, garages and all bedrooms (apart from toilets or bathroom).

Interconnect all Alarms

- | | |
|---|--|
|  | Multi-Sensor or Smoke Alarms located: |
| | <ul style="list-style-type: none"> • on each storey • every 7.5 m of hallways and escape routes • within 3m of all bedroom doors (apart from toilets & bathrooms ☒) |
|  | Heat Alarms located in: |
| | <ul style="list-style-type: none"> • each Kitchen (Heat Alarms must be within 5.3m of potential fire sources) |
|  | Multi-Sensor or Heat Alarms located in: |
| | <ul style="list-style-type: none"> • each Living room (i.e. most frequently used daytime room) |

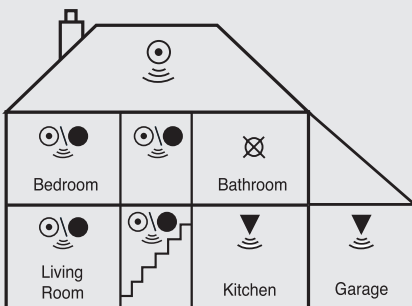

Multi Storey Dwelling LD1

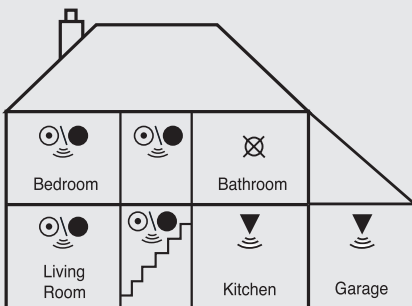

Multi Storey Dwelling LD2

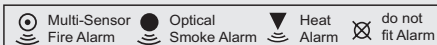

Selecting Alarm Type

Optical/Ionisation/Heat Alarm Selection Locations & Performance			
	Alarm Type		
	Optical ¹	Ionisation ²	Heat
Locations			
Hall, Corridors, Escape Routes	✓✓✓	✓✓	X
Kitchens	X	X	✓✓✓
Living Rooms	✓✓✓	✓✓	✓ ³
Bedrooms	✓✓✓	✓✓	X
Shower / Bathroom	X	X	X
Fire Response			
Slow Smouldering Fires (polyurethane foam, ignited bedding etc.)	✓✓✓	✓✓	X
Fast Flaming Fires (chip pans, flaming wood/plastic, oil, solvents etc.)	✓✓	✓✓✓	X
Temperature >58°C (only in areas with cooking fumes, steam, very dirty/dusty)	X	X	✓✓✓ ⁴
Nuisance Alarm Immunity			
Cooking Fumes	✓✓	✓ ⁵	✓✓✓
Steam, Condensation & Dust Build-up	✓	✓✓	✓✓✓
✓✓✓ - Best ✓✓ - Good ✓ - Acceptable X - Not Suitable			

¹ Optical Smoke Alarms are recommended due to their excellent response to smouldering fires. If there is likely to be problems with steam, contamination or dust build-up, or if there is significant risk of a fast burning clean fire an Ionisation Smoke Alarm should be fitted.

² Ionisation and Optical Smoke Alarms should be fitted for the fastest response to all types of fires.

³ Some Fire authorities (concerned with the slow response of Heat Alarms) advise that Smoke Alarms should be fitted. This is acceptable according to BS 5839-6 provided there are clearly not going to be problems with nuisance/false alarms. Fit Heat Alarms only if nuisance/false alarms are very likely and it is acceptable that a warning will only be given by the Heat Alarm when there is a very significant flaming fire in the room. If the door(s) and windows are not closed to contain the fire and heat, it is extremely unlikely that the Heat Alarm would respond before a Smoke Alarm sited outside in the corridor.

⁴ In enclosed kitchens with doors closed.

⁵ Greatly depends on ventilation and distance from source of fumes.

Grade D System

The mains powered Smoke and Heat Alarms with battery back-up covered by these instructions are suitable for Grade D System.

A Grade D system is needed for:

- new or materially altered dwellings, up to three-storeys, with no floor over 200m²
- existing dwellings with poor structural fire precautions, up to three storeys, with no floor over 200m²
- Houses in Multiple Occupation (HMOs) of one or two-storeys, with no floor over 200m²
- Individual dwellings units of two or more rooms in HMOs

Check that a Grade D system is adequate for the dwelling into which the system is being installed.

Positioning Alarms

The locations must comply with applicable building regulations.

Hot smoke rises and spreads out, so a central ceiling position is the preferred location. The air is “dead” and does not move in corners, therefore Smoke & Heat Alarms must be mounted away from corners. Place the unit:

- At least 0.3m away from walls. See **Figure 1**.
- At least 0.3m from any light fitting or decorative object which might obstruct smoke / heat entering the Alarm.

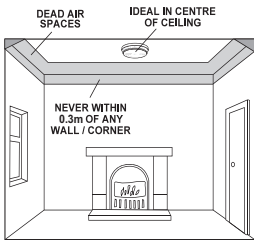

Figure 1

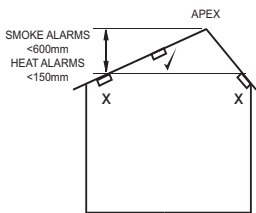

Figure 2

Sloping Ceiling

With a sloping or peaked ceiling install a Smoke Alarm within 600mm of the peak or a Heat Alarm within 150mm of the peak (measured vertically). If this height is less than 600mm for Smoke Alarms or 150mm for Heat Alarms it is regarded as being flat (see **Figure 2**).

Wall mounting of Smoke Alarms (only):

If ceiling mounting is impractical, Smoke Alarms may be mounted on a wall, provided that:

- a) the top of the detection element is between 150mm and 300mm below the ceiling;
- b) the bottom of the detection element is above the level of any door openings;

Wall mounting should only be considered where close spaced beams or similar obstructions may preclude ceiling mounting. It is considered to be the responsibility of the installer/client to determine if the presence of asbestos in the ceiling material would make ceiling mounting ‘impractical’.

Locations To Avoid

DON'T place Smoke Alarms in any of the following areas:

- *Bathrooms, kitchens, shower rooms, garages* or other rooms where the smoke alarm may be triggered by steam, condensation, normal smoke or fumes. Keep at least 6 metres away from sources of normal smoke/fumes.

DON'T place Heat Alarms in any of the following areas:

- *Bathrooms, shower rooms* or other rooms where the unit may be triggered by steam or condensation.

DON'T place Smoke or Heat Alarms in any of the following areas:

- Places where the normal temperature can exceed 40°C or be below 4°C (e.g. *attics, furnace rooms, directly above ovens or kettles* etc.) as the heat/steam could cause nuisance/false alarms.

- Near a *decorative object, door, light fitting, window moulding* etc., that may prevent smoke or heat from entering the Alarm.
- Surfaces that are normally warmer or colder than the rest of the room (e.g. *attic hatches*). Temperature differences might stop smoke or heat from reaching the unit.
- Next to or directly above *heaters or air conditioning vents, windows, wall vents* etc. that can change the direction of airflow.
- In very *high or awkward areas* (e.g. over stairwells) where it may be difficult to reach the alarm (for testing, hushing or battery replacement).
- Locate away from very *dusty or dirty areas* as dust build-up in the chamber can impair performance. It can also block the insect screen mesh and prevent smoke from entering the smoke detector chamber.
- Locate the unit at least 1m from *dimmer controlled lights and wiring* as some dimmers can cause interference.
- Locate unit at least 1.5m and route wiring at least 1m away from *fluorescent light fittings* as electrical “noise” and/or flickering may affect the unit. Do not wire into the same circuit as fluorescent lights or dimmers.
- Do not locate in *insect infested areas*. Small insects getting into the smoke detector chamber can cause intermittent alarms. Insects and contamination on the Heat Alarm sensor can increase its response time.

Installation

The Alarm is designed to be permanently mounted, using it's own built-in terminal block to connect it to the mains. The mounting plate can be screwed directly to the ceiling. Alternatively it can be screwed to a standard junction box. It requires a current of 40mA. The Alarm must not be exposed to dripping or splashing. There are important markings on the underside of the alarm.

Caution

Alternative Energy Sources - (Wind, Solar, UPS etc.)

This product is designed to be connected to a Pure or True Sine Wave 230 Vac supply.

If connecting to a power source that utilises an inverter, e.g. PV solar panel, the Total Harmonic Distortion (THD) must be less than 5%. If in doubt please check with the manufacturer of the inverter.

This also applies to battery powered UPS (Uninterruptible Power Supply) inverters.

Light Dimmer Circuits – The Alarms **must not** be powered from a light dimmer circuit.

IMPORTANT PRECAUTION: Do not install the Alarms in new or renovated buildings until all work is completed (including floor coverings) and the building has been fully cleaned. The wiring can be installed when appropriate. *(Excessive dust and debris from building work can contaminate the smoke chamber or heat sensor and cause problems, it will also invalidate the guarantee)*. If it must be installed, first cover it completely, particularly around the edges, with a dust cover (eg. with the elasticated cover supplied or a plastic bag), until all cleaning is finished.

The Alarm must not be connected when the house wiring insulation is being checked with high voltages. i.e. Do not use a high voltage insulation tester on the alarm.

WARNING: Mains operated Alarms should be installed and interconnected by a qualified electrician in accordance with the Regulations for Electrical Installations published by the Institution of Electrical Engineers (BS7671). Failure to install this Alarm correctly may expose the user to shock or fire hazards.

WARNING: The Alarm must be continuously powered 24 hours a day so it is important that it is not on a circuit that can be turned off by a switch.

Note: BS 5839-6: 2013 gives the following recommendations regarding the mains supply to be used in a Grade D system (The Ei141RC, Ei146RC Smoke Alarms and Ei144RC Heat Alarms can be used in a Grade D system). The power supply for the Alarms should be derived from the public electricity supply to the dwelling. The mains supply to the Alarms should take the form of either:

(a) an independent circuit at the dwelling's main distribution board, in which case no other electrical equipment should be connected to this circuit (other than a dedicated monitoring device installed to indicate failure of the mains supply to the Alarms); or

(b) a separately electrically protected, regularly used local lighting circuit.

Alarms should be connected on a single final circuit, unless the means of interconnection is by radio signals (e.g. RadioLINK).

(See BS 5839-6: 2013 for further information)

Note: The Ei168RC RadioLINK Base can be used to eliminate interconnect wiring, make system extensions and provide simple and cost effective compliance with BS 5839-6: 2013.

Mounting & Wiring Alarms

1. Select a location complying with the advice in the (Positioning Alarms section).
2. Disconnect the AC mains supply from the circuit that is going to be used.
3. Lift off the wiring cover as shown in **Figure 3**.

The house wiring must be connected to the terminal block on the mounting plate as follows:

L: Live - connect to the house wires coloured brown or marked L.

N: Neutral - connect to the house wires coloured blue or marked N.

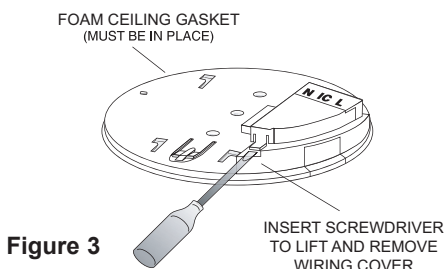

Figure 3

See page 20 for information on interconnection.

Note: Wiring must be installed in compliance with local regulations.

Warning: Mixing the Live and Neutral connections when interconnecting alarms will damage all the alarms - ensure that the same colours are used throughout the premises for Live, Neutral and Interconnect wires.

We strongly recommend that you check for the following **before connecting the Alarm:**

- check for Live and Neutral using a two probe tester.
- check for Live using a neon tester.

- check that the Interconnect wire is NOT connected to Live, Neutral or Earth. **Do not use an Earth wire for the Interconnect line.**

N.B. The Alarm does not need to be earthed. However the terminal marked \oplus is provided for the convenience of the installer so that any copper Earth wire or cable coloured green & yellow, can be safely terminated.

To interconnect the Alarms connect all the IC terminals together as shown in **Figure 6**.

4. If the mains wires are recessed, bring the wires through the rear hole in the mounting plate as shown in **Figure 4**.

If the mains wires are being brought along the surface:

(a) position the mounting plate so the cable trunking is as shown in **Figure 4**.

(b) the mounting plate has a removable section, take it out to interface directly with 25mm conduit as shown in **Figure 5**. If interfacing to 16mm conduit carefully cut around the marked section, leaving the top intact and replace the section. (If you are not using surface wiring, the removable section must be left in place for electrical safety reasons).

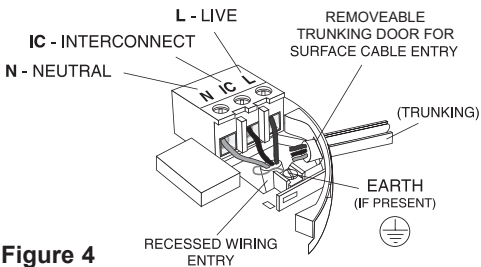
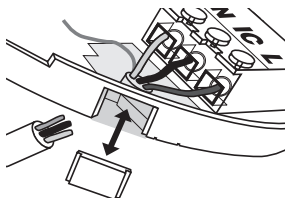

Figure 4

There are two other positions which are also suitable for the surface wiring to enter (and exit) the alarm, one next to the removable section and another directly opposite.

Figure 5



5. Carefully align the mounting plate and screw into place. Connect the wires to the terminal block. With recessed wiring, ensure the rear gasket seals around the edge of the hole in the ceiling or wall. This is to prevent air draughts affecting the smoke/heat entering the Alarm. If the hole is too large or the Alarm does not seal it, it should be sealed with silicone rubber or equivalent.

6. Attach the battery to the battery snaps. Carefully line up the unit on the base and slide on.

7. Press and hold the test/hush button for 10 seconds. The horn will sound. On release of the test button the local alarm will stop sounding immediately and the interconnected Alarms will stop sounding a few seconds later.

8. Connect the mains power to the Alarm circuit. Check the green light is on.

9. Attach the 'Smoke Alarm' identification label provided to the distribution board to identify the alarm circuit.

10. Attach the 'Mains Smoke / Heat Alarms' label provided on or near the distribution board and write in date installed and the number of Alarms on the circuit.

Ensure the alarm operates correctly - see "TESTING & MAINTENANCE" section on page 3.

Interconnecting Alarms

Note: A maximum of twelve Ei141RC / Ei144RC / Ei146RC Smoke or Heat Alarms may be interconnected. Up to 8 additional accessories may also be connected. *If you wish to connect more than 12 Alarms contact your local distributor.*

Systems using more than 3 or 4 Alarms must be very carefully planned to ensure nuisance/false alarms are not excessive. e.g. from cooking fumes or steam. The following is suggested:

- An Alarm Control Switch (model Ei1529RC) or a Fire/CO Alarm Controller (model Ei450) should be incorporated into the system and be readily accessible to all occupants so that the source of an alarm can be quickly identified.
- All Alarms must be cleaned and maintained regularly.
- A qualified person must be on call to quickly remove any nuisance units (i.e. units with red light flashing rapidly) which are causing all the other Alarms to sound.

WARNING: Do not connect these Alarms to any other model produced by another manufacturer. Doing so may damage the Alarms and could result in a shock or fire hazard.

Wiring must be installed in compliance with local regulations.

In the UK it is recommended that the following coloured cores are used (for example with triple flat 6243Y cable).

230V supply	Brown
Neutral	Grey - sleeved blue at terminations
Interconnect	Black

The interconnect wire (minimum 0.75mm² cable) must be treated as if it was Live. It should be insulated and sheathed.

A maximum of 250 metres of wire can be used (maximum resistance between detectors 50 Ohms).

These Smoke/Heat Alarms should be interconnected only within the confines of a single family living unit. If they are connected between different units there may be excessive nuisance/false alarms. Everybody may not be aware that they are being tested or that it is a nuisance/false alarm caused by cooking etc.

Note: Heat Alarms **must** be interconnected to other Smoke Alarms. They are not suitable as a fire safety device unless they are part of a fire safety system i.e. when interconnected to one or more Smoke Alarms.

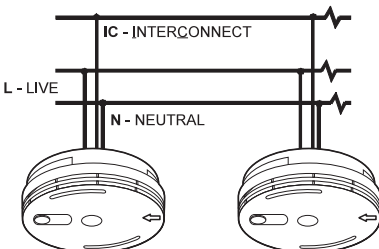

Figure 6